

track.28

ficha técnica

datasheet



ref. 5551686

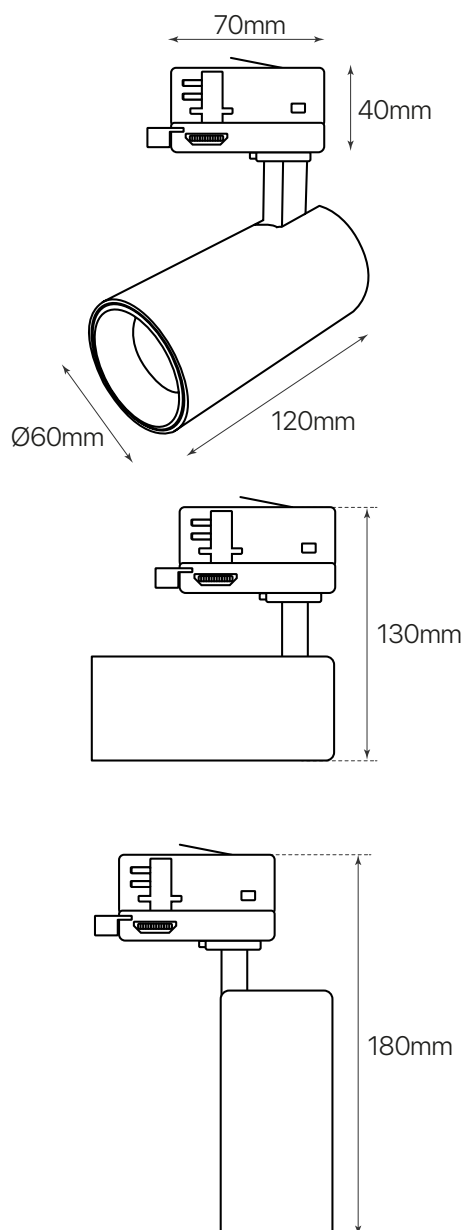

Nombre / Name	Track.28
Referencia / Reference	5551686
Materiales / Materials	Aluminio + PC / Aluminum + PC
Difusor / Diffuser	PC
Potencia / Power	13W
Temperatura de color / Color temperature	6000K
Flujo luminoso / Luminous flux	1352lm
Dimable / Dimmable	No
Ángulo de apertura / Beam angle	36°
Ángulo de inclinación / Inclination angle	-
IP	20
IK	-
F.P. / P.F.	>0,5
UGR	<16
IRC	>80
Chip	EPISTAR COB
Driver	i-TEC series
Vida media (duración) / Average life	30.000h
Clase energética / Energy class	A+
Aislamiento eléctrico / Electrical isolation	Clase I / Class I
Colores / Colors	Negro / Black
Medida exterior / Product size	Ø60mm x 120mm
Medidas de corte / Cutting measurements	-
Tª (ambiente/trabajo) / Tª (environment/work)	-25°C~45°C
Input	AC100V~240V
Output	DC25-42V 300mA
Frecuencia / Frequency	50/60Hz
Peso / Weight	350g
Certificados / Certificates	CE
Garantía / Warranty	2 años / 2 years